

PRD Series Power Relay

- Contact ratings to 50A
- Magnetic blowouts available for switching DC loads
- Contact arrangement up to 2 form C (2CO)
- 1 form C auxiliary switch available
- UL class B insulation

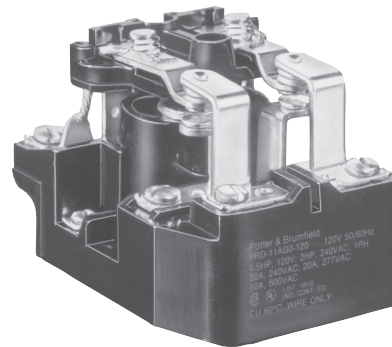

Typical applications
Industrial controls, lighting.

Approvals

UL E22575; CSA LR15734; VDE Reg.Nr.C144
Models with all screw terminals are UL Listed. Others are UL Recognized.
Technical data of approved types on request.

Contact Data

Contact arrangement	1 and 2 form A (NO); 1 and 2 form C (CO); 1 form X (NO-DM)
Rated voltage	600VAC, 125VDC
Rated current	50A
Contact material	Ag, AgCdO, W
Min. recommended contact load	1A, 12VDC or 12VAC
Initial contact resistance	75mΩ max.
Initial voltage drop	75mV
Frequency of operation	7200 ops/hr
Operate/releases time max.	40/20ms
Bounce time max.	10ms

Contact ratings

Type	Load	Cycles
UL 508¹⁾		
Models with screws or quick connects for main terminals		
Code Y, Ag, 1 pole		
	25A, 277VAC	100x10 ³
	1HP, 120VAC	100x10 ³
	2HP, 250VAC	100x10 ³
	10A, 600VAC	100x10 ³
	7A, 50VDC, resistive	100x10 ³
Code Y, Ag, 2 pole		
	25A, 240VAC	100x10 ³
	20A, 277VAC	100x10 ³
	1HP, 120VAC	100x10 ³
	2HP, 250VAC	100x10 ³
	7A, 50VDC, resistive	100x10 ³
	10A, 600VAC	100x10 ³
Code G, AgCdO, 1 pole		
	30A, 277VAC, resistive	100x10 ³
	1.5HP, 120VAC	100x10 ³
	2HP, 250VAC	100x10 ³
	10A, 600VAC	100x10 ³
Code G, AgCdO, 2 pole		
	30A, 240VAC	100x10 ³
	20A, 277VAC	100x10 ³
	1.5HP, 120VAC	100x10 ³
	2HP, 250VAC	100x10 ³
	10A, 600VAC	100x10 ³

1) Any PRD relay deviating electrically or physically from the standard models in the table is not UL or CSA listed. All horsepower ratings are for single phase motors..

Contact ratings (continued)

Type	Load	Cycles
UL 508¹⁾		
Models with screws or quick connects for main terminals		
Code F, AgCdO, 1 pole		
	50A, 240VAC, general purpose ²⁾	20x10 ³
	30A, 277VAC, resistive	100x10 ³
	1.5HP, 120VAC	100x10 ³
	2HP, 250VAC	100x10 ³
	10A, 600VAC	100x10 ³
Code F, AgCdO, 2 pole		
	50A, 240VAC, general purpose ²⁾	20x10 ³
	30A, 240VAC	100x10 ³
	20A, 277VAC	100x10 ³
	1.5HP, 120VAC	100x10 ³
	2HP, 250VAC	100x10 ³
	10A, 600VAC	100x10 ³
Code H, Ag with magnetic blowout, 1 or 2 pole		
	20A, 125VDC	100x10 ³
	1/3HP, 125VDC	100x10 ³
Code J, AgCdO with magnetic blowout, 1 or 2 pole		
	20A, 125VDC	100x10 ³
	1/3HP, 125VDC	100x10 ³
Code N, W stationary with AgCdO movable, 1 or 2 pole		
	25A, 250VAC	100x10 ³
	1HP, 125VAC	100x10 ³
	2HP, 250VAC	100x10 ³

UL 508¹⁾

Models with box lugs for main terminals		
Code P, Ag, 1 form X		
	50A, 277VAC, general purpose	100x10 ³
	30A, 277VAC, ballast	6x10 ³
	15A, 277VAC, tungsten	6x10 ³
	102LRA, 17FLA, 240VAC	30x10 ³
	120LRA, 20FLA, 120VAC	30x10 ³
	1.5HP, 120VAC	30x10 ³
	3HP, 240VAC	30x10 ³

Factory ratings

Models with box lugs for main terminals		
Code R, Ag with magnetic blowout, 1 form X		
	60A, 28VDC, resistive	100x10 ³
	30A, 125VDC	100x10 ³

Mechanical endurance DC Coil, 1x10⁶ ops.; AC Coil 5x10⁵ ops.

Auxiliary Snap-Action Switch Contact Data

Contact arrangement	1 form C (CO)
Rating	5A, 120VAC, 60Hz., 25°C
Contact material	Ag

PRD Series Power Relay (Continued)

Coil Data

Coil voltage range	6 to 110VDC 6 to 480VAC
Coil insulation system according UL	Class B

Coil versions, DC coil

Coil code	Rated voltage VDC	Operate voltage VDC	Release voltage VDC	Coil resistance $\Omega \pm 10\%$	Rated coil power W
6	6	4.5	0.6	18	2
12	12	9	1.2	71	2
24	24	18	2.4	288	2
48	48	36	4.8	1150	2
110	110	82.5	11	6050	2

All figures are given for coil without preenergization, at ambient temperature +23°C.
Other coil voltages on request.

Coil versions, AC coil

Coil code	Rated voltage VAC	Operate voltage VAC	Release voltage VAC	Coil resistance $\Omega \pm 15\%$	Rated coil power VA
6	6	5.1	0.6	0.86	9.8
12	12	10.2	1.2	3.2	9.8
24	24	20.4	2.4	12	9.8
120	120	102	12	290	9.8
240	240	204	24	1200	9.8
480	480	408	48	4500	9.8

All figures are given for coil without preenergization, at ambient temperature +23°C.
Other coil voltages on request.

Insulation Data

Initial dielectric strength	
between open contacts	2000V _{rms}
between contact and coil	2000V _{rms}
between adjacent contacts	2000V _{rms}
Initial insulation resistance	
between insulated elements	100M Ω

Other Data

Material compliance: EU RoHS/ELV, China RoHS, REACH, Halogen content refer to the Product Compliance Support Center at www.te.com/customer-support/rohssupportcenter

Ambient temperature
AC coil: -55°C to 45°C
DC coil: -55°C to 80°C

Category of environmental protection
IEC 61810

RT0 - open relay

Terminal type Screw, Quick connects, Box lugs

Weight 284g

Packaging/unit tray/20 pcs., box/40pcs.

Accessories

Product Code	Description
35D013	Metal dust cover

Dimensions

PRD/PRDA 1, 3, 5 and 7

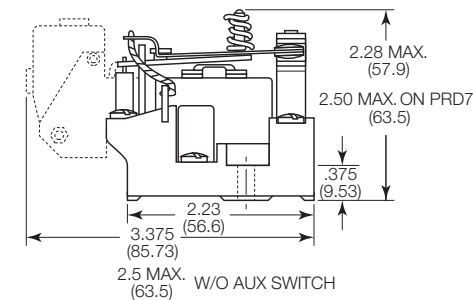
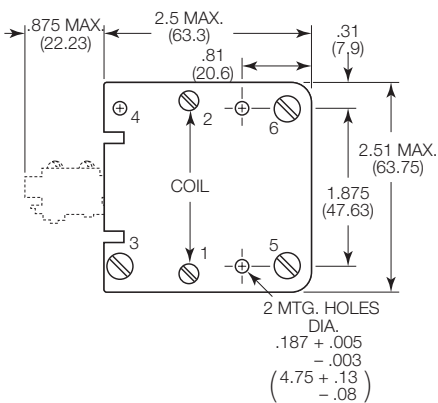

PRD/PRDA 11

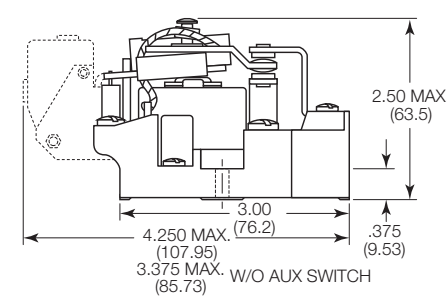
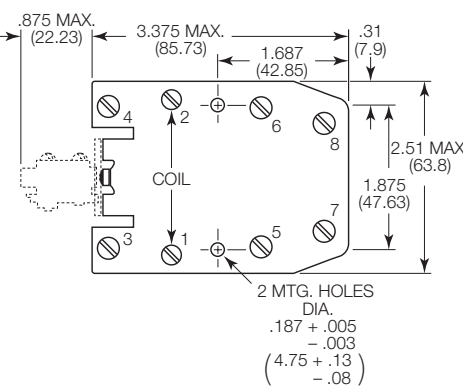

PRD-3_P and R

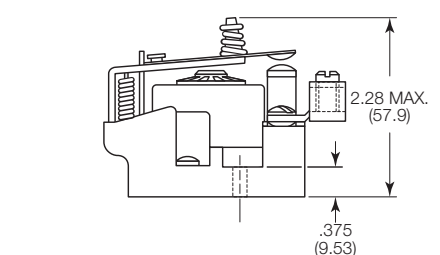
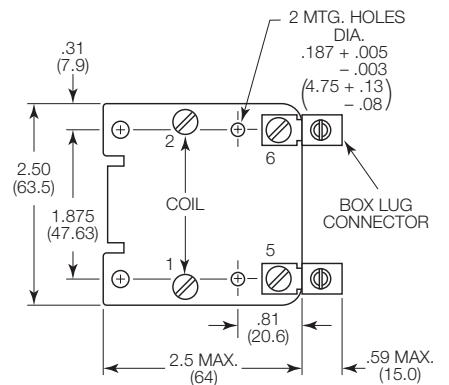

PRD Series Power Relay (Continued)

Terminal assignment for models with magnetic blowout

PRD3 with blowout

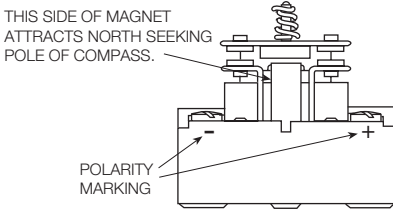

PRD7 with blowout

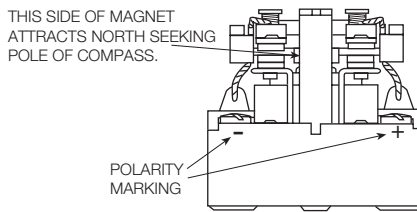

PRD 11 with blowout

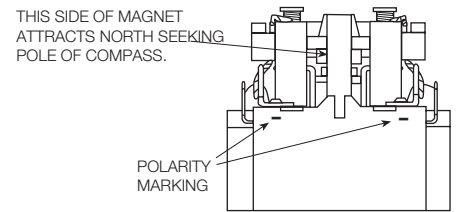

Product code structure

Typical product code

PRD -7 A Y 0 -120

Type

- PRD** Open relay
- PRDA** Open relay with aux. 1 form C (CO) snap-action switch

Main contact arrangement

- | | |
|--|-----------------------------|
| 1 1 form A (1 NO) | 3 1 form X (1 NO-DM) |
| 5 1 form C (1 CO) | 7 2 form A (2 NO) |
| 7V 2 form A (2 NO) with 3mm contact gap ¹⁾ | 11 2 form C (2 CO) |

¹⁾ Code 7V is only available as a UL Recognized model, not UL Listed

Coil input

- | | |
|----------------------|-------------|
| A AC, 50/60Hz | D DC |
|----------------------|-------------|

Main contact material and type

- Y** .312" (7.92mm) dia. Ag [25A max. rating]
- G** .312" (7.92mm) dia. AgCdO [30A max. rating]
- F** .312" (7.92mm) dia. AgCdO [50A max. rating] ²⁾
- H** Ag with magnetic blowout [20A DC max. rating] ³⁾
- J** AgCdO with magnetic blowout [20A DC max. rating]
- N** W stationary & AgCdO movable [25A max. rating] ⁴⁾
- P** Ag [50A max. rating] ⁵⁾
- R** Ag with magnetic blow out [50A max. rating] ⁵⁾

²⁾ Available with Main contact arrangement code 1, 5, 7 or 11 only, and Termination code 0 or A only.
³⁾ Available with Main contact arrangement code 3, 7 or 11 only
⁴⁾ Available with Main contact arrangement code 1, 5, 7 or 11 only.
⁵⁾ Available with Main contact arrangement code 3 only, and Termination code 4 only.

Termination

PRD types only

- 0** #8-32 screw term. for main contacts, #6-32 screw term. for coil.
- 1** .250" (6.35mm) QC for main contacts and coil
- 3** #8-32 screw term. for main contacts, .250" (6.35mm) QC for coil.
- 4** Box lug term. which accept #6 - #14 wire for main contacts, #6-32 screw term. for coil. ⁶⁾

⁶⁾ Available with Main contact arrangement code 3 only, and Main contact material code P or R only.

PRDA (with aux. switch) types only

- A** #8-32 screw term. for main contacts, #6-32 screw term. for coil, screw term. for aux. switch
- B** .250" (6.35mm) QC for main contacts, coil and aux. switch
- L** Twin .250" (6.35mm) QC for main contacts, .250" (6.35mm) QC for coil and aux. switch

Coil voltage

Coil code: please refer to coil versions table

PRD Series Power Relay (Continued)

Product Code	Arrangement	Material	Coil	Terminals	Part Number	
PRD-3AY0-120	1 form X, 1 NO-DM	Ag	120VAC	Screw	7-1393127-9	
PRD-3AG0-120		AgCdO, 30A			6-1393127-9	
PRD-3AJ0-120		AgCdO, mag blowout			7-1393127-4	
PRD-3AJ3-24	1 form C, 1 CO	Ag, mag blowout	24VAC	Screw / QC	7-1393127-5	
PRD-3DH0-24			24VDC		8-1393127-6	
PRD-3DY0-12		Ag	12VDC	Screw	9-1393127-5	
PRD-3DY0-24			24VDC		9-1393127-6	
PRD-3DY0-110			110VDC		9-1393127-4	
PRD-5AY0-24				24VAC		1393128-6
PRD-5AY0-120			120VAC		1393128-5	
PRD-5AY0-240			240VAC	Screw	1393128-7	
PRD-5DF0-12	1 form A, 2 NO	AgCdO, 50A	12VDC	QC	2-1423100-4	
PRD-5DY0-12		Ag			1-1393128-6	
PRD-5DY0-24			24VDC		1-1393128-7	
PRD-7AG0-120	2 form A, 2 NO	AgCdO, 30A	120VAC	Screw / QC	9-1393129-5	
PRD-7AY0-24		Ag	24VAC		1393130-9	
PRD-7AY0-120			120VAC		1393130-7	
PRD-7AY0-240			240VAC		1-1393130-0	
PRD-7AY3-120			120VAC		1-1393130-2	
PRD-7DG0-24		AgCdO, 30A	24VDC		Screw	1-1393130-6
PRD-7DH0-48		Ag, mag blowout	48VAC			2-1393130-1
PRD-7DY0-12		Ag	12VDC			2-1393130-8
PRD-7DY0-24			24VDC			2-1393130-9
PRD-11AF0-240		2 form C, 2 CO	AgCdO, 50A		240VAC	
PRD-11AG0-24	AgCdO, 30A		24VAC	1-1393127-1		
PRD-11AG0-120			120VAC	1393127-9		
PRD-11AG0-240			240VAC	1-1393127-2		
PRD-11AH0-120	Ag, mag blowout	120VAC		1-1393127-6		
PRD-11AY0-24	Ag	24VAC		2-1393127-9		
PRD-11AY0-120		120VAC		2-1393127-6		
PRD-11AY0-240		240VAC		3-1393127-0		
PRD-11AY0-480		480VAC		3-1393127-1		
PRD-11DF0-12	AgCdO, 50A	12VDC		2-1423100-2		
PRD-11DF0-110		110VDC		2-1423100-9		
PRD-11DG0-12	AgCdO, 30A	12VDC		3-1393127-5		
PRD-11DG0-24		24VDC		3-1393127-8		
PRD-11DH0-12	Ag, mag blowout	12VDC		4-1393127-7		
PRD-11DH0-24		24VDC		4-1393127-9		
PRD-11DH0-48		48VDC		5-1393127-0		
PRD-11DH0-110		110 VDC		4-1393127-6		
PRD-11DJ0-24	AgCdO, mag blowout	24 VDC		5-1393127-5		
PRD-11DY0-12	Ag	12 VDC		6-1393127-1		
PRD-11DY0-24		24 VDC		6-1393127-2		
PRD-11DY0-48		48 VAC		6-1393127-3		
PRD-11DY0-110		110 VDC		6-1393127-0		
PRDA-11AGA-120	AgCdO, 30A	120 VAC		7-1393131-4		
PRDA-11AYA-120				7-1393131-9		

PRD accessory

Product Code	Description	Part Number
35D013	Metal dust cover enclosure	5-1393158-2

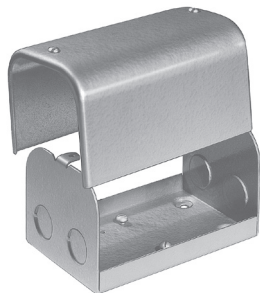

35D013 Dust Cover

PRD dust cover has a steel base with knockouts for 0.5" (12.7mm) dia. conduit and a cover fitted with two screws. Fits PRD relays, except with auxiliary contacts. Finished in gray baked enamel.

Mounting:
Three No. 10 holes on 1.875" (47.63mm) x 4.125" (104.77mm) centers.

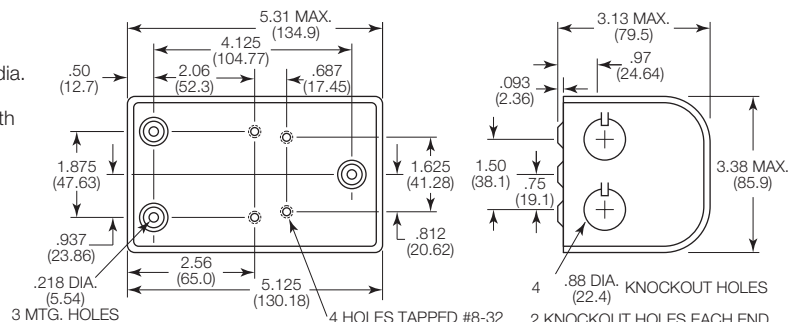

Note: Additional unused holes may be present in dust cover base.